

ASSEMBLY INSTRUCTIONS MANUAL

#60617 IVORY SPIRAL HANDBAG RACK

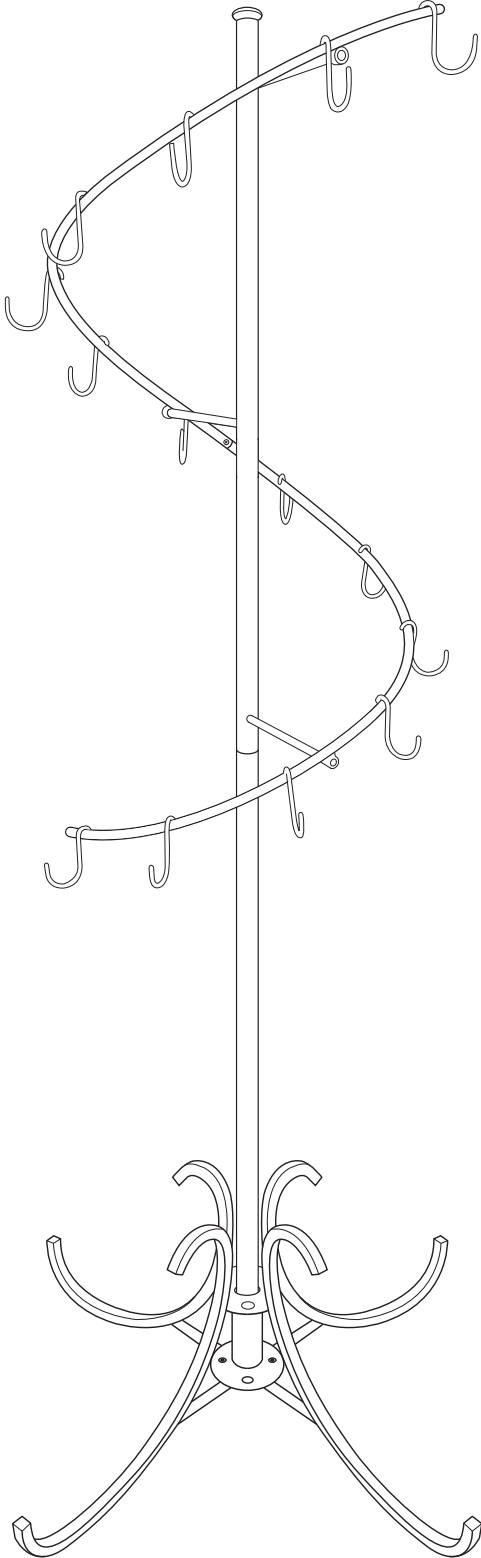

ASSEMBLY INSTRUCTIONS MANUAL

#60617 IVORY SPIRAL HANDBAG RACK

RECOMMENDED TOOLS FOR ASSEMBLY:

ALLEN WRENCH (LARGE)

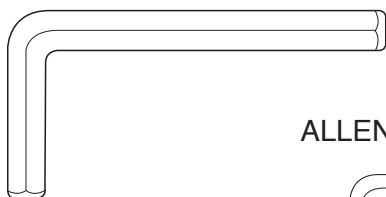

BOX WRENCH

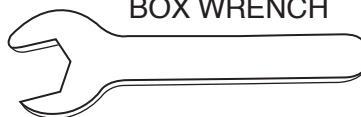

ALLEN WRENCH (SMALL)



PHILLIPS SCREW DRIVER
(NOT INCLUDED)

PARTS IN CARTON:

BOTTOM POLE
(1 EACH)



TOP SPIRAL
HANGER
(1 EACH)

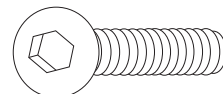
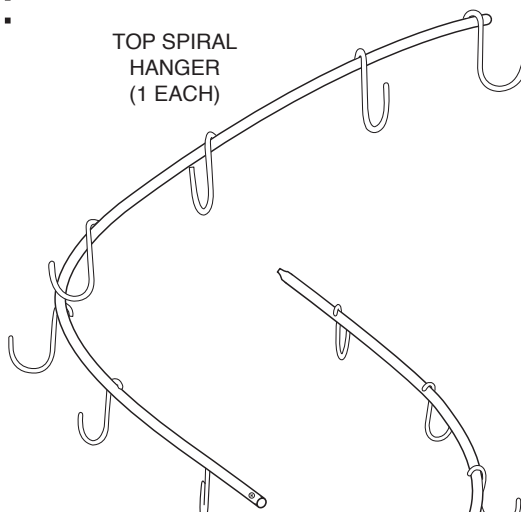

ALLEN WRENCH SCREW - 1"
(1 EACH)

TOP POLE
(1 EACH)

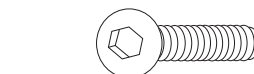
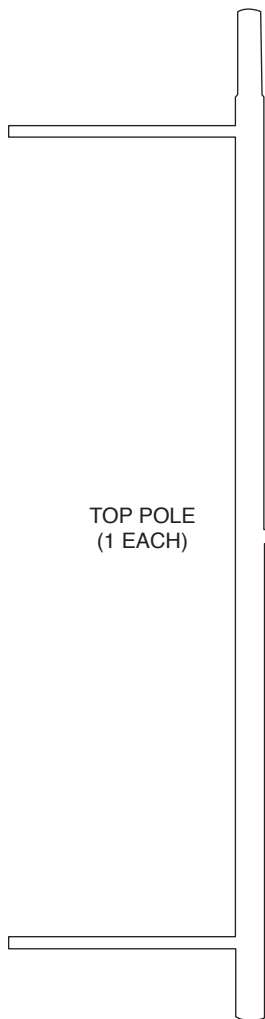

ALLEN WRENCH SCREWS - 1/4"
(7 EACH)

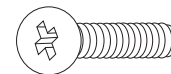
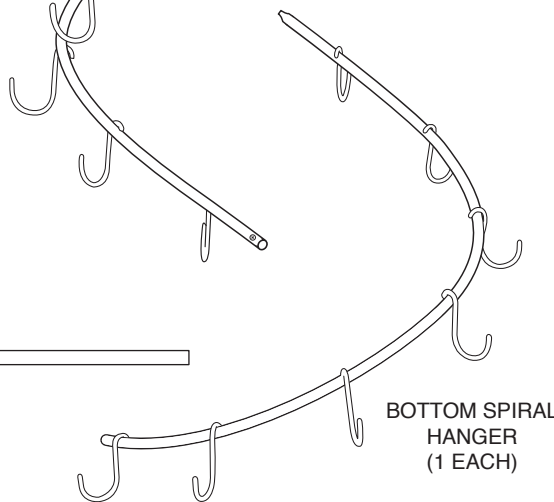

PHILLIPS HEAD SCREW - 1/4"
(1 EACH)

BOTTOM SPIRAL
HANGER
(1 EACH)



NUTS
(4 EACH)

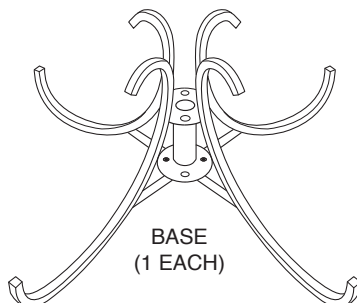

BASE
(1 EACH)

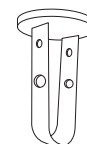

TOP CAP
(1 EACH)

ASSEMBLY INSTRUCTIONS MANUAL

#60617 IVORY SPIRAL HANDBAG RACK

STEP 1

OPEN BASE LEGS (BASE COMES ASSEMBLED CLOSED). PLACE (4 - 1/4") ALLEN SCREWS IN THE HOLES ON THE CENTER OF THE BASE. (2) ON TOP TIER AND (2) ON BOTTOM TIER. SCREW ON NUTS TO ALL (4) SCREWS (TIGHTEN WITH SMALL ALLEN WRENCH PROVIDED).

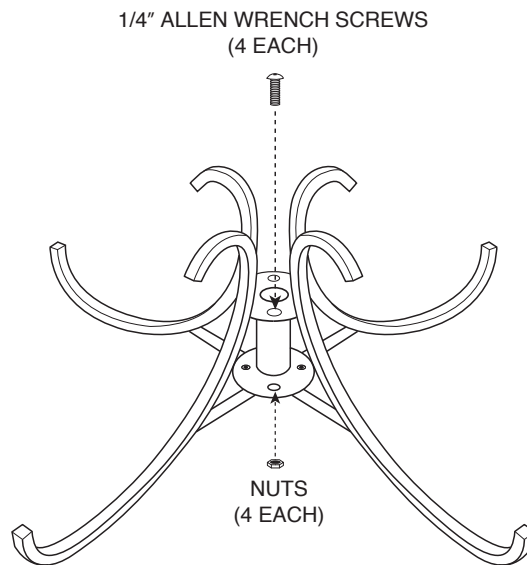

STEP 2

PLACE BASE ON IT'S SIDE. INSERT BOTTOM POLE IN OPENING ON TOP OF BASE UNTIL TIGHT. PLACE 1" ALLEN SCREW IN THE (CENTER) HOLE IN BOTTOM OF BASE. TURN CLOCKWISE UNTIL TIGHT. (TIGHTEN WITH LARGE ALLEN WRENCH PROVIDED).

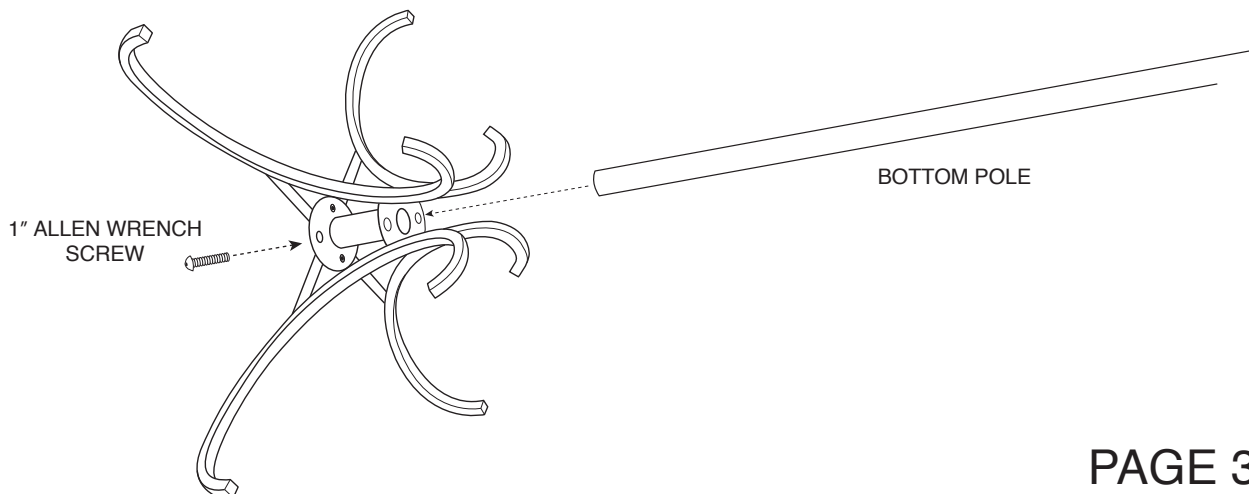

ASSEMBLY INSTRUCTIONS MANUAL

#60617 IVORY SPIRAL HANDBAG RACK

STEP 3

PLACE BASE ON SOLID SURFACE. INSERT TOP POLE INTO BOTTOM POLE UNTIL SECURE.

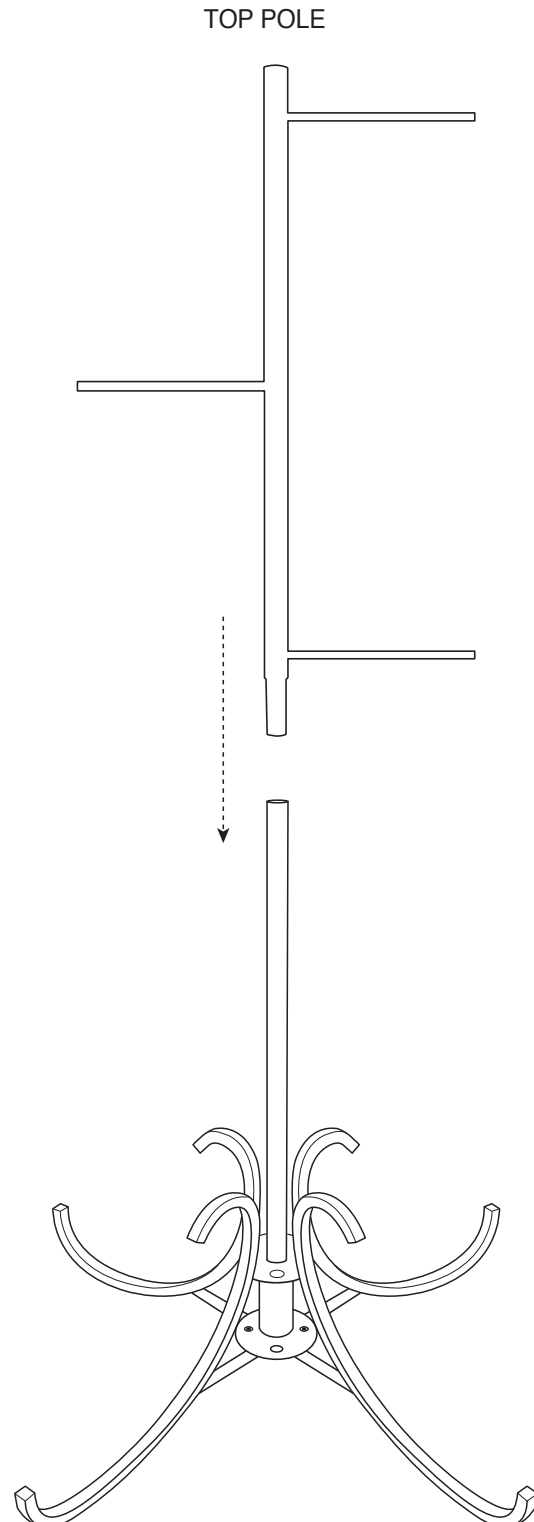

ASSEMBLY INSTRUCTIONS MANUAL

#60617 IVORY SPIRAL HANDBAG RACK

STEP 4

PLACE BOTH SPIRAL HANGERS ON A FLAT SURFACE (TOP & BOTTOM). LINE BOTH ENDS UP SO THEY INSERT INTO ONE ANOTHER (THIS CAN ONLY GO ONE WAY, OPPOSITE ENDS HAVE END CAPS).

ONCE BOTH HANGERS ARE TOGETHER, LINE UP HOLES AND INSERT 1/4" PHILLIPS HEAD SCREW. TIGHTEN WITH SCREWDRIVER (NOT PROVIDED).

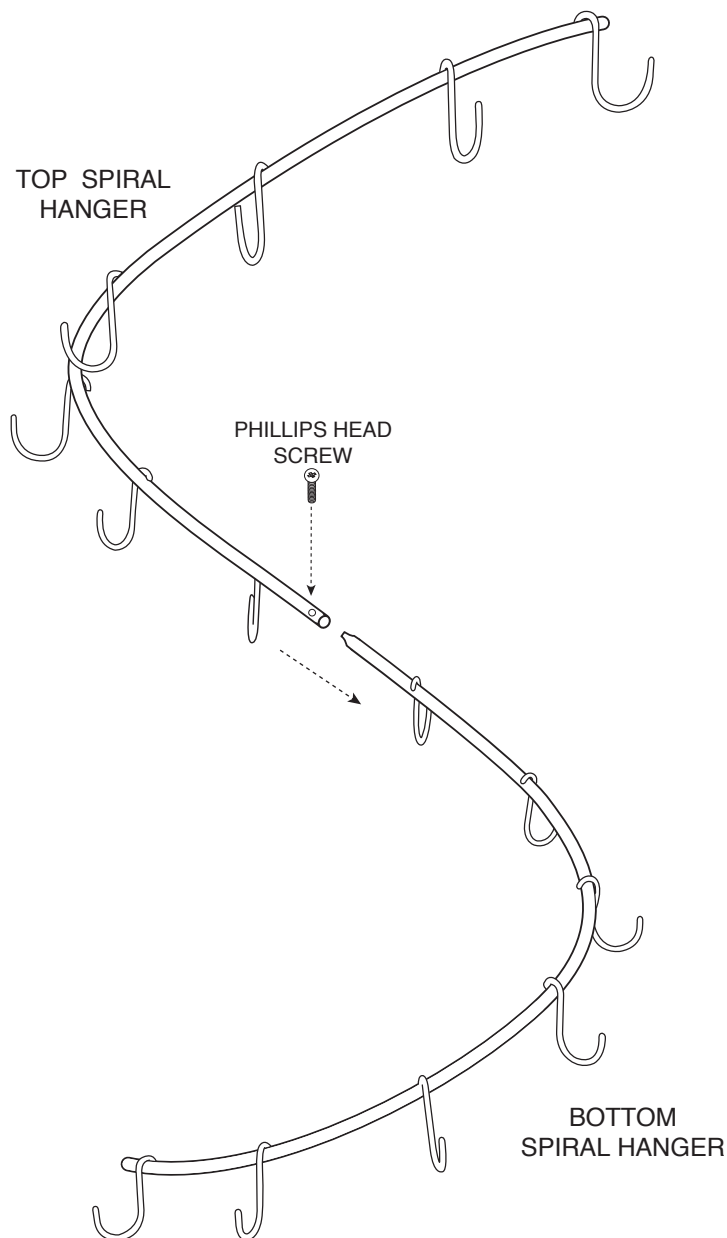

ASSEMBLY INSTRUCTIONS MANUAL

#60617 IVORY SPIRAL HANDBAG RACK

STEP 5

LOWER SPIRAL HANGER DOWN OVER TOP POLE. (MAKE SURE THE CIRCLES ARE ON BOTTOM & AND THE TOP OF THE SPIRAL HANGER HAS 2 CIRCLES ON THE END PAST THE ATTACHMENT HOLE)

INSERT ALLEN WRENCH SCREW INTO THE TOP ATTACHMENT HOLE (DO NOT TIGHTEN), REPEAT FOR THE MIDDLE AND BOTTOM SECTION.

ONCE SPIRAL HANGAR IS ALIGNED AND SCREWS ARE SET, TIGHTEN SCREWS WITH SMALL ALLEN WRENCH.

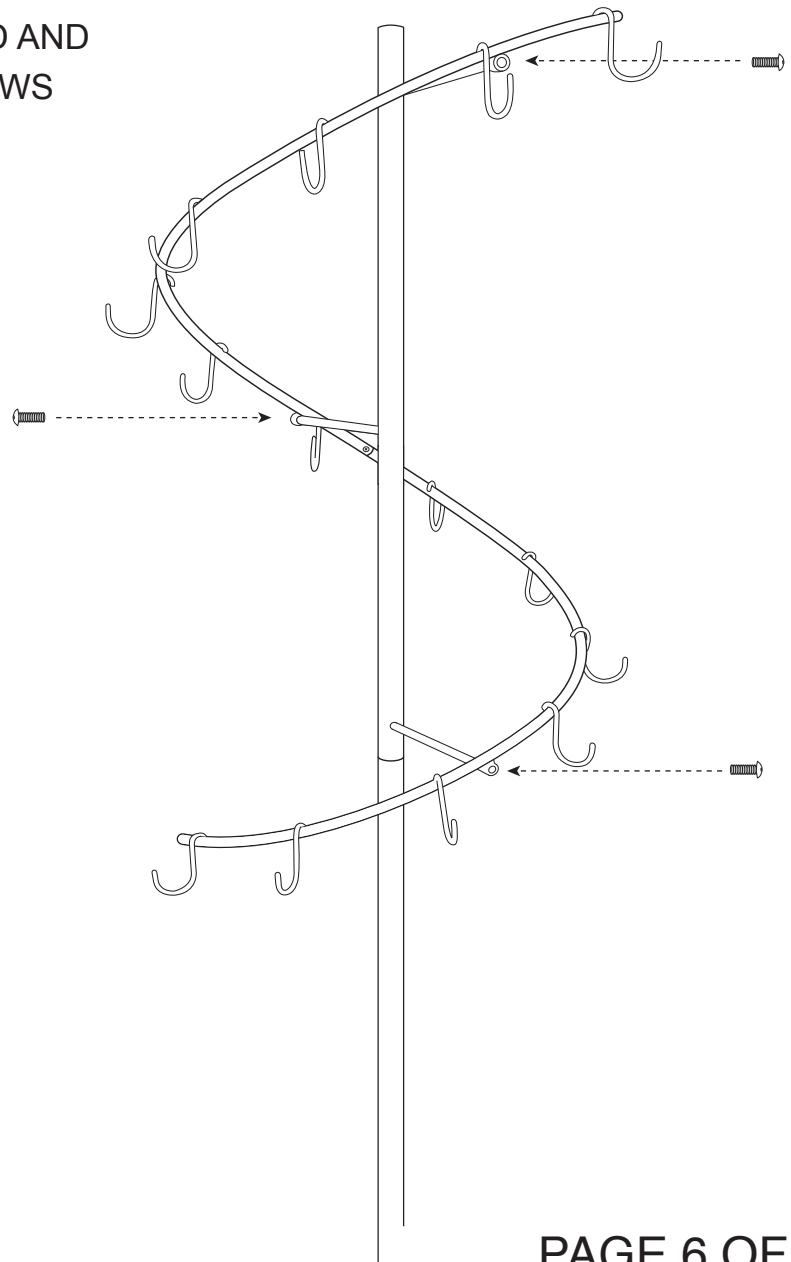

ATTACHMENT HOLES (3)

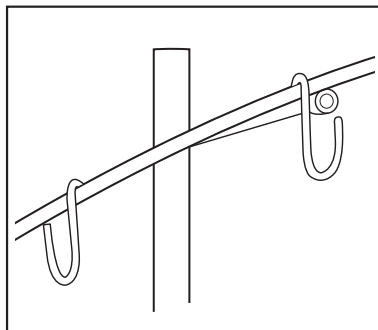

ASSEMBLY INSTRUCTIONS MANUAL

#60617 IVORY SPIRAL HANDBAG RACK

STEP 6

INSERT TOP CAP.

THIS COMPLETES ASSEMBLY.

