

CHANGING THE INK ROLLER

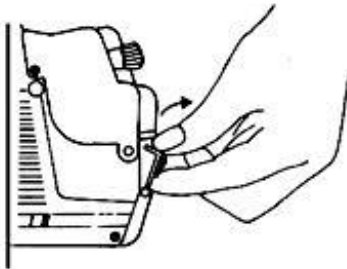

Press and take out the ink roller case



Squeeze in as indicated to release ink roller.

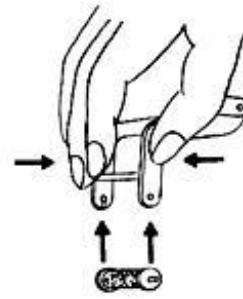

While still squeezing — insert new ink roller. Replace case.

LOADING AND USING YOUR

1-LINE LABELER



1. Pull out tab and lift the label compartment in the direction of arrow.



2. Insert label roll with tape going over top of guide. Close compartment.

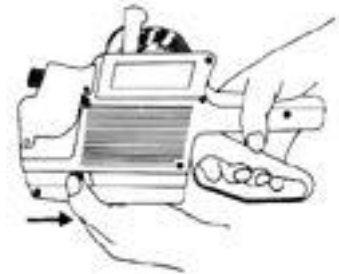

3. Pull back handles to release base plate



4. Feed labels through labeler allowing an extra 4 inches to extend below base plate.

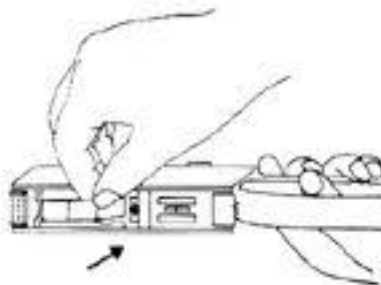

5. Close base plate and remove labels from backing. Insert end of label tape into slot marked "LABEL" (behind base plate, not the small narrow slot.)

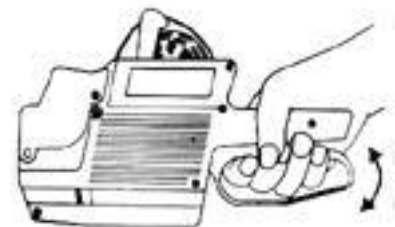

6. Squeeze handle 7-8 times to feed tape around pin-feed wheel and out the back slot.

USING LABELER

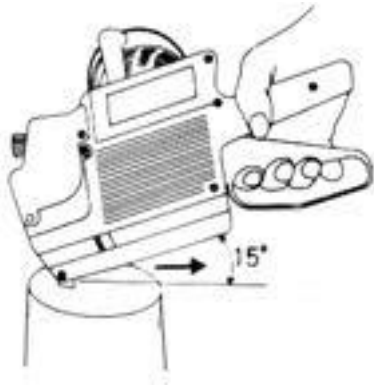

To affix label, squeeze handle and touch onto merchandise with a rolling motion, lifting handle approx. 15°.



SETTING THE PRINT WHEELS

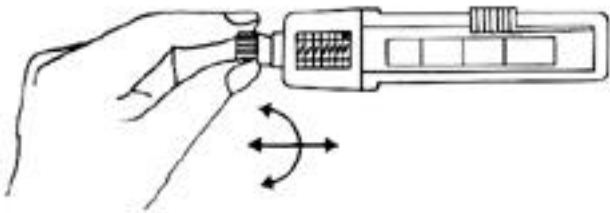

Pull dial shaft outward and rotate each wheel to the desired position.

- When price is set, slide the dial shaft back in.

ADJUSTING THE PRINTING POSITION

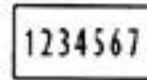
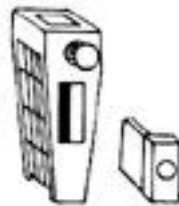

Insert the letter head fixed key to the left for middle position printing.

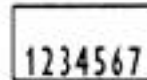
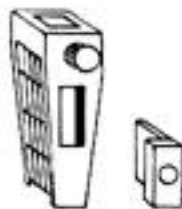

Insert the letter head fixed key to the right for lower position printing.