

ASSEMBLY INSTRUCTIONS MANUAL

#55204 REVOLVING CARDED JEWELRY DISPLAYS

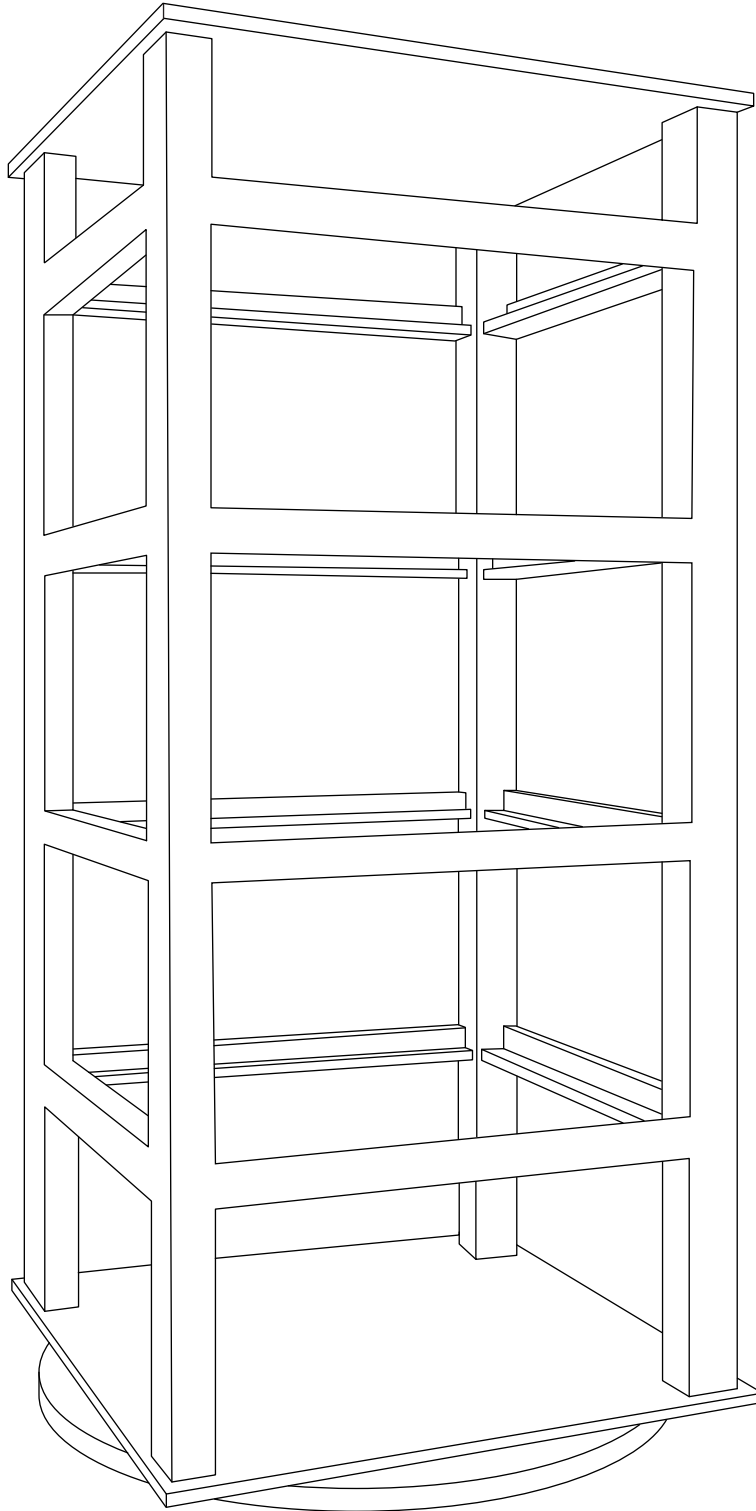

ASSEMBLY INSTRUCTIONS MANUAL

#55204 REVOLVING CARDED JEWELRY DISPLAYS

PARTS IN CARTON:



NUTS
(8 EACH)

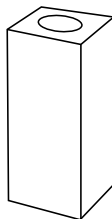

SPACERS
(4 EACH)



POLES
(4 EACH)

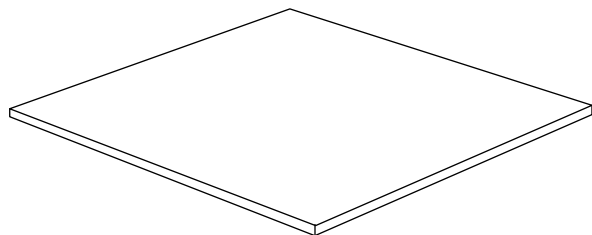

TOP BOARD
(1 EACH)

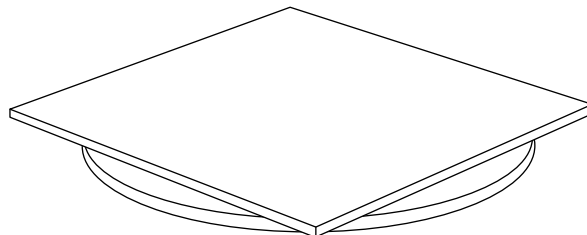

BASE
(WITH TURNING TABLE)
(1 EACH)

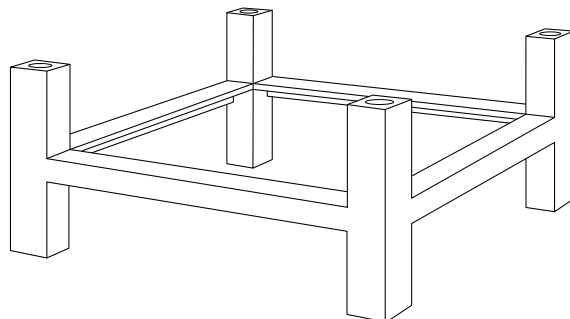

L GROOVED SQUARE FRAME
(4 EACH)

ASSEMBLY INSTRUCTIONS MANUAL

#55204 REVOLVING CARDED JEWELRY DISPLAYS

STEP 1

TAKE (4) TOP NUTS AND SCREW THEM ON THE THE (4) POLES UNTIL SECURE.

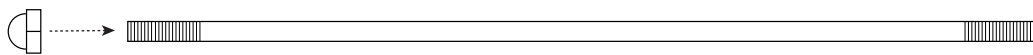

STEP 2

INSERT THE (4) POLES (WITH TOP NUTS ON THE BOTTOM) THROUGH THE (4) HOLES ON THE TOP BOARD AND STAND ON A SOLID FLAT SURFACE.

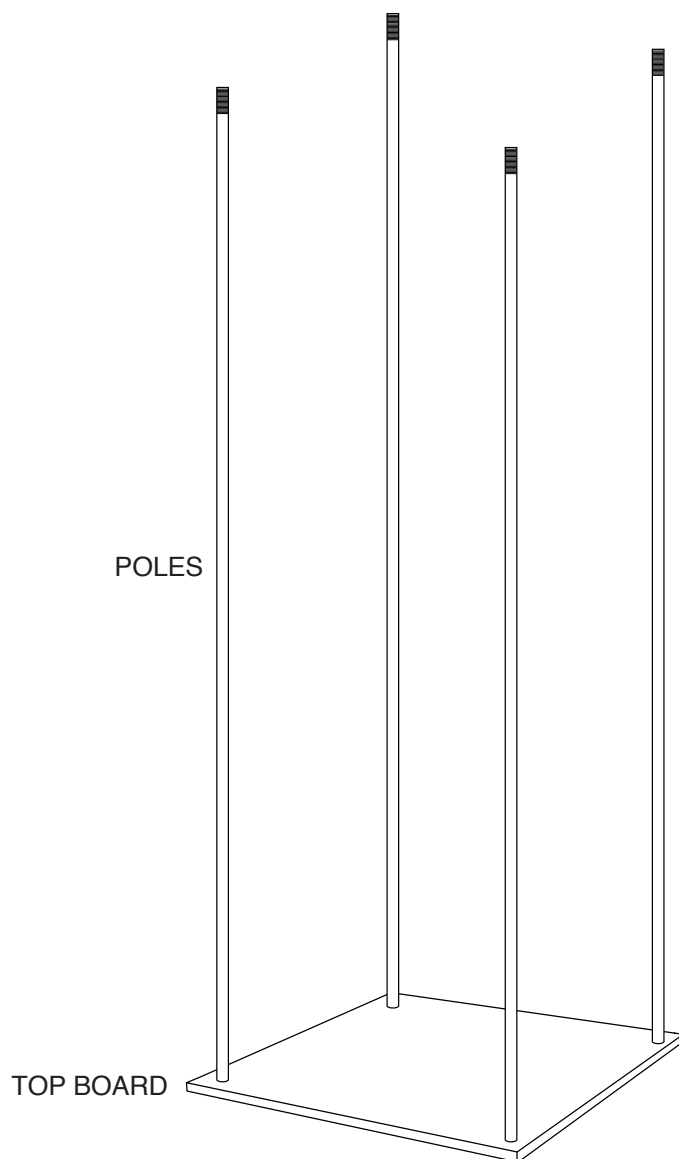

ASSEMBLY INSTRUCTIONS MANUAL

#55204 REVOLVING CARDED JEWELRY DISPLAYS

STEP 3

SEAT THE L GROOVED SQUARE FRAME ONTO THE (4) POLES WITH THE FLAT SIDE FACING UP, AND THE GROOVED SIDE FACING DOWN (SEE INSET).

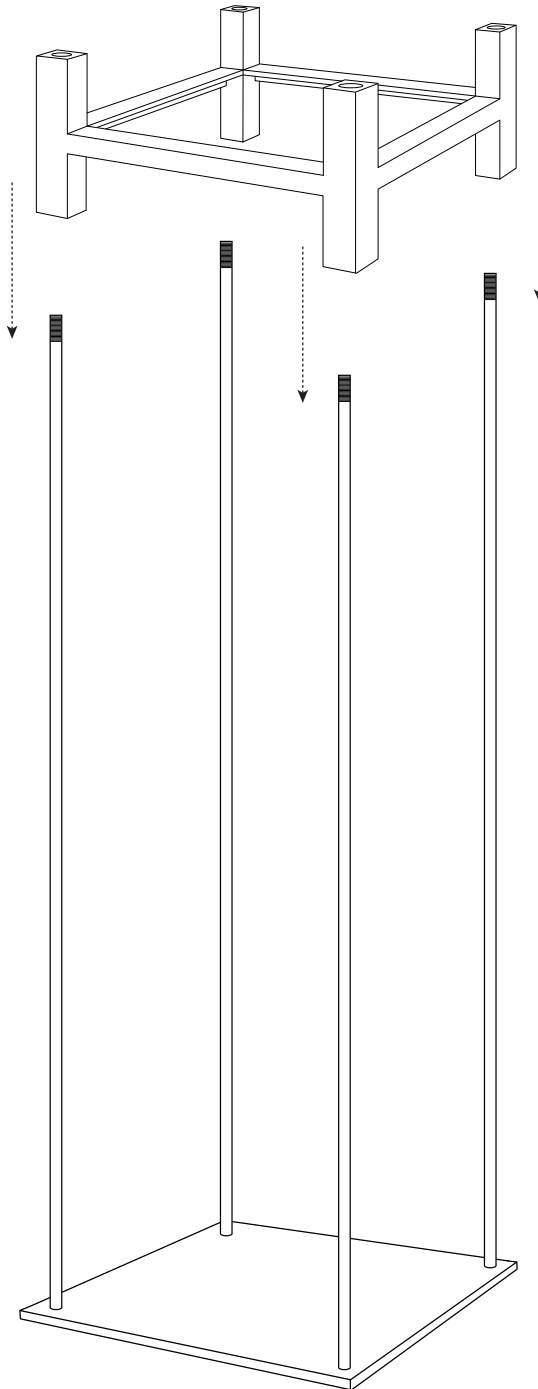
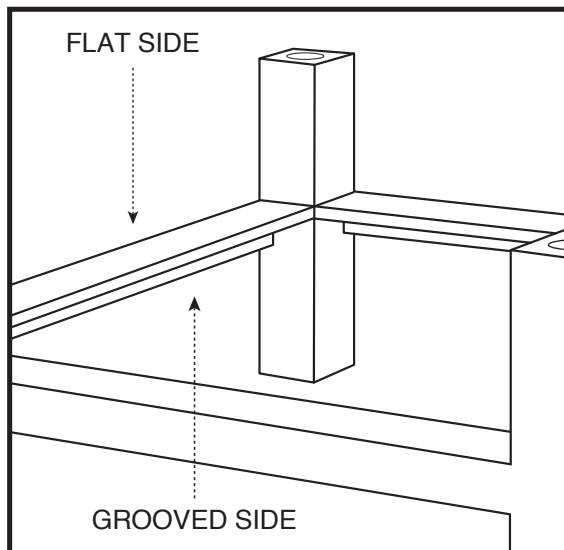

ASSEMBLY INSTRUCTIONS MANUAL

#55204 REVOLVING CARDED JEWELRY DISPLAYS

STEP 4

STACK ALL REMAINING L GROOVED SQUARE FRAMES ONTO THE POLES ONE BY ONE UNTIL ALL (4) ARE SEATED.

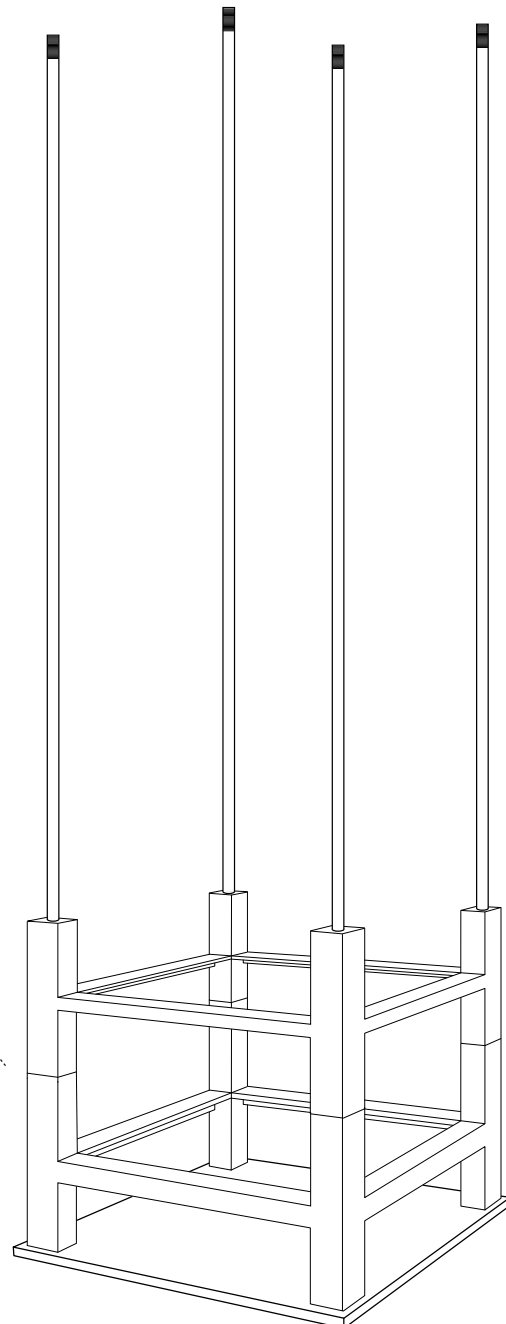
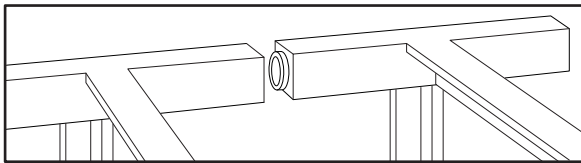

ASSEMBLY INSTRUCTIONS MANUAL

#55204 REVOLVING CARDED JEWELRY DISPLAYS

STEP 5

INSERT (4) SPACERS THROUGH THE (4) POLES AND SEAT ON TOP OF THE LAST L GROOVED SQUARE FRAME. (MAKE SURE THE MALE SIDE OF THE SPACERS ARE FACING DOWN INTO THE (4) POLES).

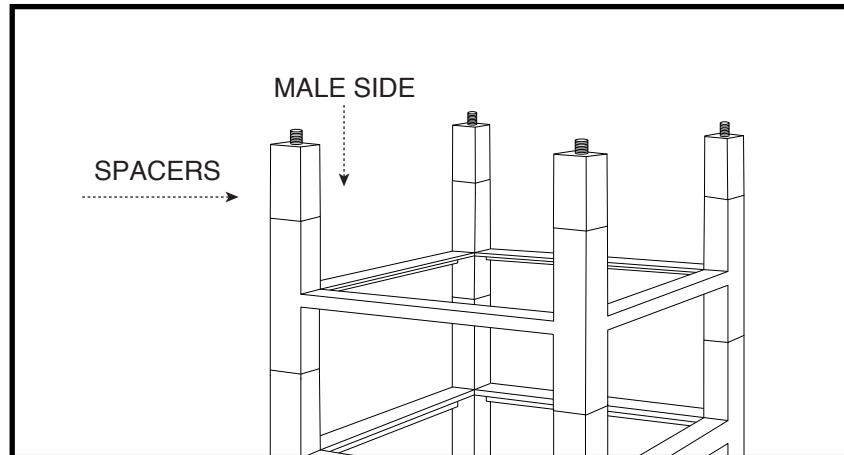

STEP 6

ATTACH THE BASE BOARD WITH THE TURNING TABLE FACING UP WITH (4) NUTS TO THE (4) POLES. TIGHTEN SECURELY.

TURN DISPLAY OVER SO TURN TABLE BASE IS ON BOTTOM.

THIS COMPLETES THE ASSEMBLY.

