

ASSEMBLY INSTRUCTIONS MANUAL

#60591 BOUTIQUE COBBLESTONE 5-TIER HAT DISPLAY RACK

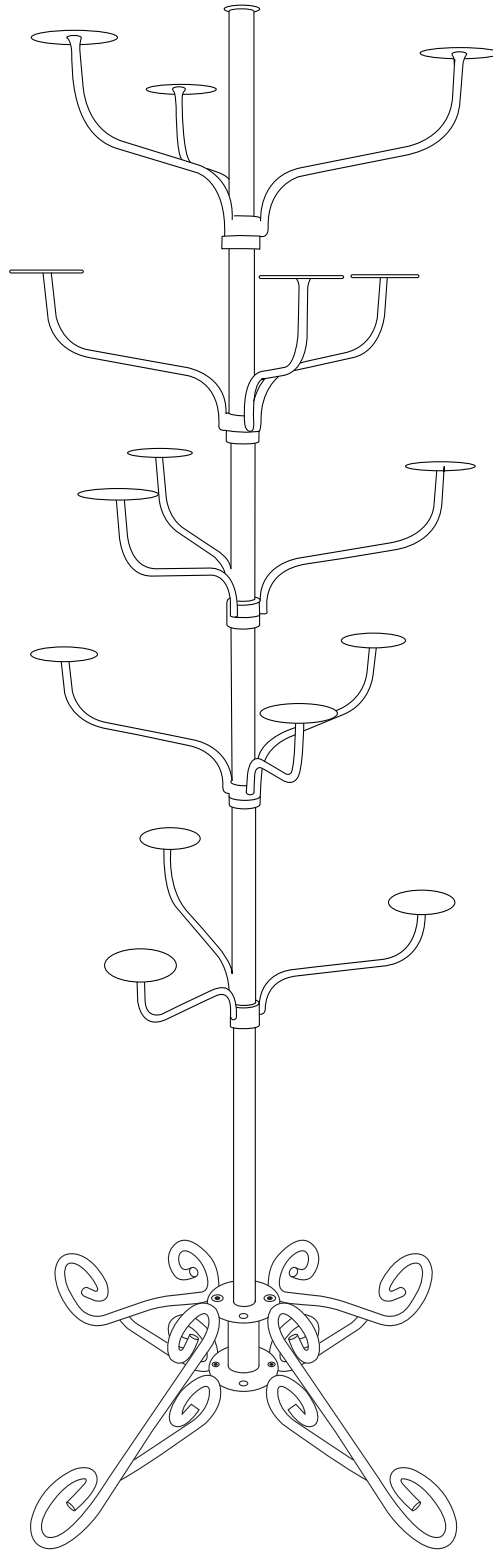

ASSEMBLY INSTRUCTIONS MANUAL

#60591 BOUTIQUE COBBLESTONE 5-TIER HAT DISPLAY RACK

RECOMMENDED TOOLS FOR ASSEMBLY:

ALLEN WRENCH (LARGE)



ALLEN WRENCH (MEDIUM)



ALLEN WRENCH (SMALL)



BOX WRENCH

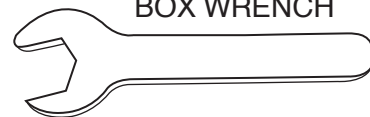

PARTS IN CARTON:

BOTTOM POLE
ONE END THREADED
(1 EACH)



TOP POLE
(1 EACH)



O-RING
(5 EACH)

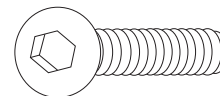
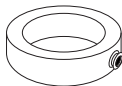

ALLEN WRENCH SCREW - 1"
(1 EACH)

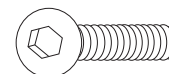

ALLEN WRENCH SCREWS - 1/4"
(4 EACH)

HAT
DISPLAY
(5 EACH)

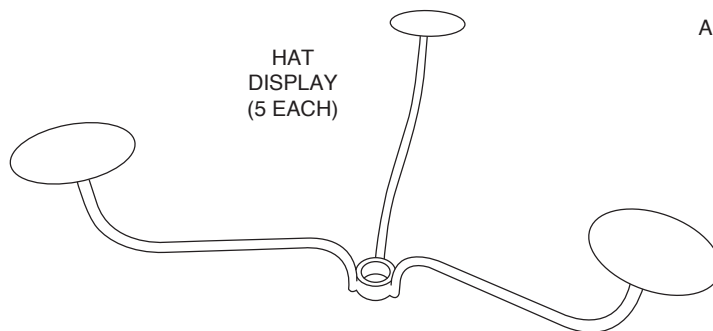

NUTS
(4 EACH)

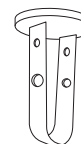

TOP CAP
(1 EACH)

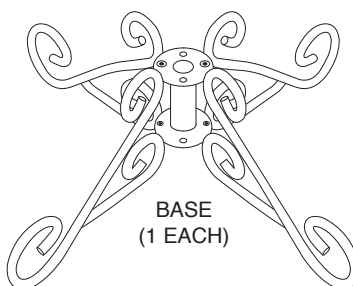

BASE
(1 EACH)

ASSEMBLY INSTRUCTIONS MANUAL

#60591 BOUTIQUE COBBLESTONE 5-TIER HAT DISPLAY RACK

STEP 1

OPEN BASE LEGS (BASE COMES ASSEMBLED CLOSED). PLACE (4 - 1/4") ALLEN SCREWS IN THE HOLES ON THE CENTER OF THE BASE. (2) ON TOP TIER AND (2) ON BOTTOM TIER. SCREW ON NUTS TO ALL (4) SCREWS (TIGHTEN WITH SMALL ALLEN WRENCH PROVIDED).

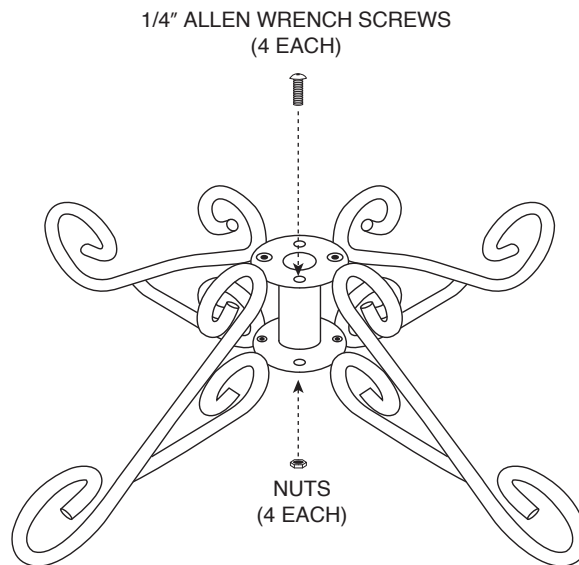

STEP 2

PLACE BASE ON IT'S SIDE. INSERT BOTTOM POLE (HAS ONE END THREADED) IN OPENING ON TOP OF BASE UNTIL TIGHT. PLACE 1" ALLEN SCREW IN THE (CENTER) HOLE IN BOTTOM OF BASE. TURN CLOCKWISE UNTIL TIGHT. (TIGHTEN WITH LARGE ALLEN WRENCH PROVIDED).

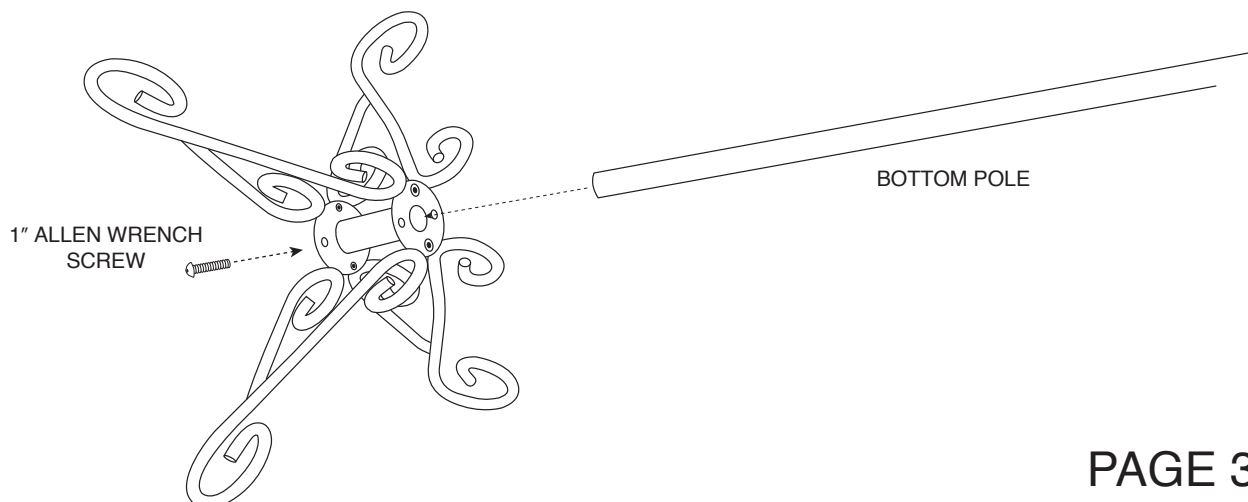

ASSEMBLY INSTRUCTIONS MANUAL

#60591 BOUTIQUE COBBLESTONE 5-TIER HAT DISPLAY RACK

STEP 3

PLACE BASE ON SOLID SURFACE. INSERT TOP POLE INTO BOTTOM POLE
(ALIGN INDENT ON RECESSED END TO DIMPLE ON BOTTOM POLE / PUSH
DOWN AND TURN CLOCKWISE UNTIL SECURE)

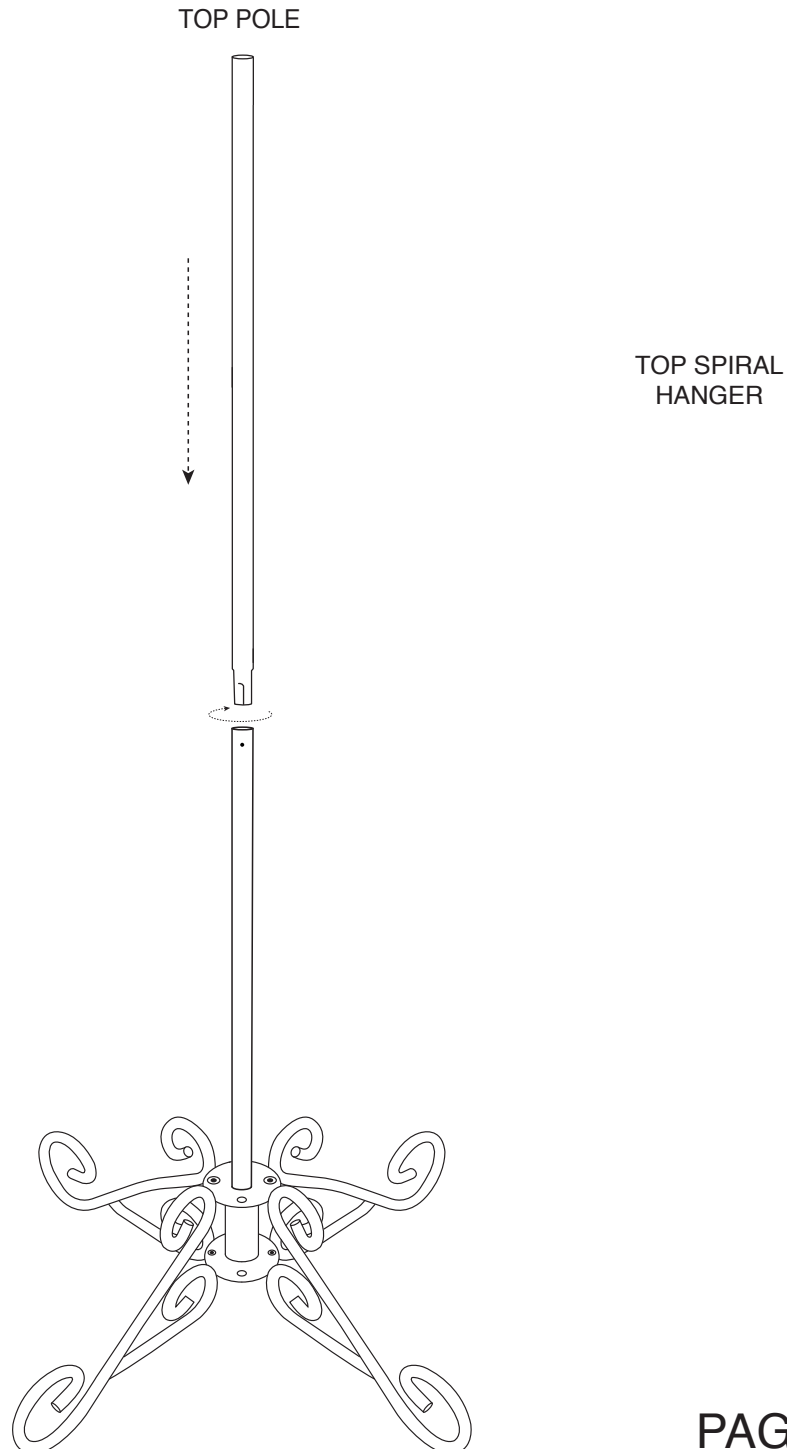

ASSEMBLY INSTRUCTIONS MANUAL

#60591 BOUTIQUE COBBLESTONE 5-TIER HAT DISPLAY RACK

STEP 4

USING A TAPE MEASURE, MEASURE DOWN FROM THE (TOP) OF THE TOP POLE AND MARK (WITH A PENCIL) WHERE YOUR O-RINGS (5) WILL GO. THESE HOLD THE HAT DISPLAYS (5) IN PLACE. THESE CAN BE ADJUSTED FIT YOUR NEEDS DEPENDING ON YOUR HAT SELECTION.

RECOMENDED O-RINGS AT 9", 17", 25", 35", AND 46".

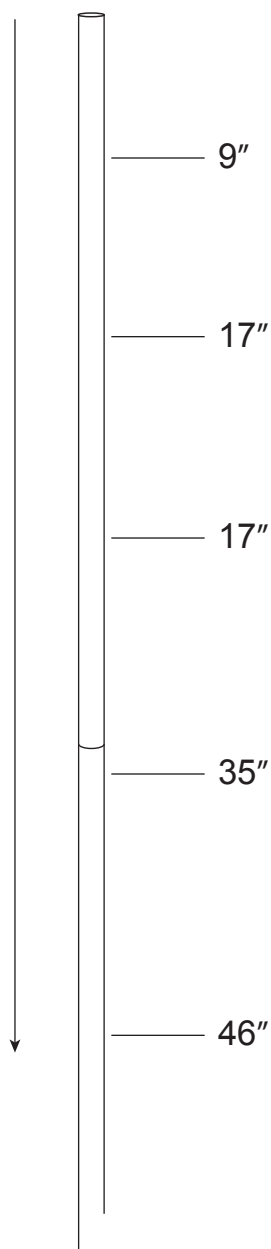

ASSEMBLY INSTRUCTIONS MANUAL

#60591 BOUTIQUE COBBLESTONE 5-TIER HAT DISPLAY RACK

STEP 5

SLIDE THE 1ST O-RING DOWNWARD ON THE TOP POLE. THIS WILL BE FURTHEST FROM THE TOP OF THE POLE (BOTTOM). LINE THE TOP OF THE O-RING UP WITH THE PENCIL MARK MADE IN STEP 4.

TIGHTEN SECURLY WITH THE SMALL ALLEN WRENCH (PROVIDED).

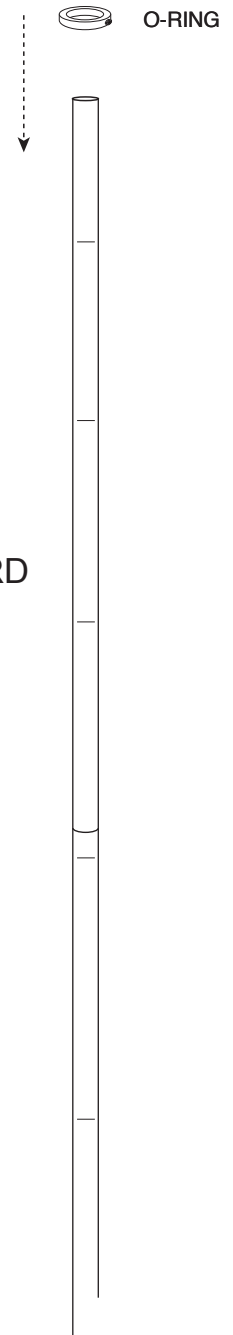

STEP 6

AFTER THE 1ST O-RING IS IN PLACE, SLIDE A HAT DISPLAY DOWNWARD ON THE POLE UNTIL IT SITS ON THE O-RING.

REPEAT STEPS 5 & 6 UNTIL ALL 5 LAYERS ARE COMPLETED.

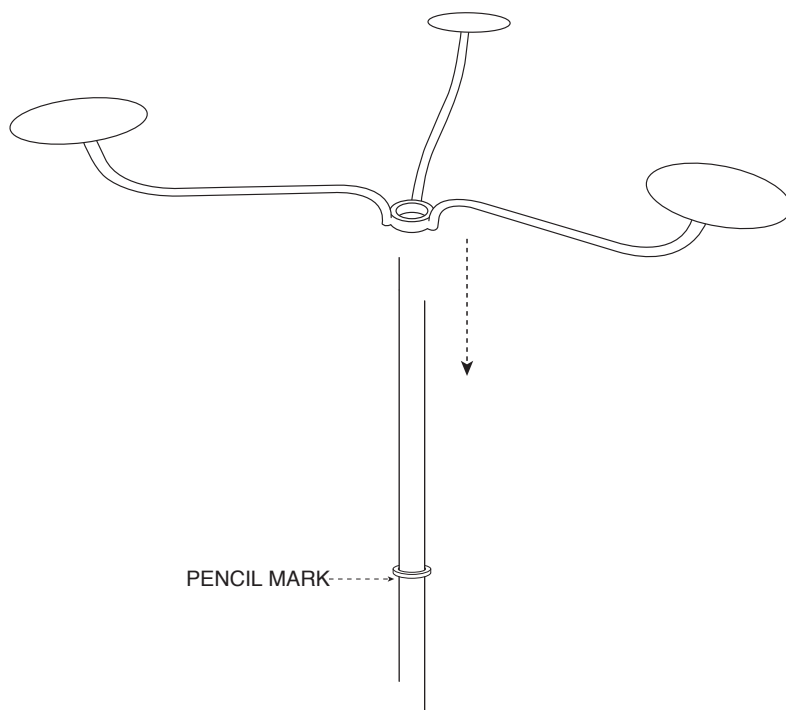

ASSEMBLY INSTRUCTIONS MANUAL

#60591 BOUTIQUE COBBLESTONE 5-TIER HAT DISPLAY RACK

STEP 6

INSERT TOP CAP.

THIS COMPLETES ASSEMBLY.

